

**Model** ST2822D/E

# Dual Handheld LCR Meter

Instruction Manual V.1.0.0



---

## **Safety Summary**

The following safety precautions are applicable to both operating and maintenance personnel and must be observed during all phases of operation, service, and repair of this instrument.

### ***DO NOT OPERATE IN A FLAMMABLE OR EXPLOSIVE ATMOSPHERE***

Do not operate the instrument in the presence of much dust, direct sunlight, high humidity, strong electromagnetic radiation, etc.

### ***NON-PROFESSIONALS SHOULD NOT OPEN THE REAR COVER***

Maintaining, substituting parts or adjusting the instrument should be made by professional maintenance personnel. Please contact relevant distributor or Sourcetric's after-sale service department.

### ***DO NOT REMOVE OR MODIFY THE INSTRUMENT***

---

Some replacements and unauthorized modifications might cause irreversible damage to the instrument.

## ***SAFETY WARNING***

Strictly follow the relevant safety statements in this manual involving safety, personnel injury, damage to the instrument, operation and environmental conditions causing poor test.

---

## Safety Guidelines

**To ensure that you use this device safely, follow the safety guidelines listed below:**

- This meter is for indoor use, altitude up to 2,000 m. For short-time outdoor use, precautions should be taken to avoid direct sunlight, water and moisture, electromagnetic radiation, dust and explosion.
- The warnings and safety precautions should be read and well understood before the instrument is used.
- Use the meter only as specified in this manual.
- Confirm that the circuits have been powered off and all capacitors in the circuits been discharged before measuring in-circuit components.
- Discharge all charging elements, such as capacitors, before testing.
- The power for the meter is supplied with a single standard 8.4 V battery. But also a line

---

operation is possible using a power adapter of 12VDC/150mA. If a power adapter is selected, please be sure to meet the safety requirements of a relevant IEC standard.

- The battery using in ST2822D/E is rechargeable. Do not charge non-rechargeable batteries.

## Safety Symbols



This symbol is a warning and indicates that the user should refer to the operating instructions located in the manual.



D C power



Indicates inside pin is positive (+), outside is negative (-) .

---

# Environmental Conditions

Operating Environment	0 °C to 40 °C
Storage Humidity	0 – 80% R.H.
Storage Environment	-20 °C to +50 °C
Pollution degree	2

---

# Contents

<b>Safety Summary</b> .....	<b>1</b>
<b>Safety Guidelines</b> .....	<b>3</b>
<b>Introduction</b> .....	<b>9</b>
<b>Package List</b> .....	<b>10</b>
<b>Front Panel Overview</b> .....	<b>12</b>
Front Panel Display Descriptions .....	13
Front Panel Buttons .....	15
Button Function Definition .....	16
LCD Display Overview .....	17
LCD Display Descriptions .....	17
Special Display Indicators .....	20
Test Port .....	21
<b>Powering Instrument</b> .....	<b>22</b>
Installing Battery .....	23
Connecting External Power Source .....	25
Low Battery Indication .....	27
Backlight Display .....	28
Charge Display .....	30

---

<b>Operation Instruction</b> .....	<b>32</b>
Data hold mode (HOLD) .....	32
Data Record Mode (REC).....	33
PRI Select Mode .....	36
SEC Select Mode .....	37
Test Frequency (FREQ) .....	37
Test Electric Level .....	38
Tolerance Mode (TOL) .....	39
Auto LCR Mode .....	42
Measurement Rate (RATE) .....	44
Series/parallel Equivalent Mode .....	44
Utility Menu (UTIL).....	46
Clear Functions (CLEAR) .....	61
Remote Control (RMT) .....	66
Fuse Detection.....	66
<b>Quick Start Guide</b> .....	<b>68</b>
CAUTION.....	68
Inductance Measurement .....	69
Capacitance Measurement.....	72
Resistance Measurement .....	74
Impedance Measurement .....	77



---

Direct Current Resistance Measurement .....	78
<b>Remote Communication .....</b>	<b>78</b>
Connecting Instrument to PC .....	79
Virtual Serial Port Configuration .....	81
RMT Operation .....	82
Command Protocols .....	84
<b>Specifications .....</b>	<b>99</b>
General Specifications .....	100
Accuracy Specifications .....	104
<b>Maintenance .....</b>	<b>114</b>
Service .....	114
Cleaning .....	115
<b>Limited Warranty .....</b>	<b>116</b>

---

## Introduction

ST2822D/E is designed for measuring inductance, capacitance and resistance of components. The instrument can be powered by an 8.4V rechargeable battery or external power adapter. This meter is not only applicable to the application occasion of bench meters but also conveniently used in the flow and handheld measurement occasions.

ST2822D/E provides the primary parameter of up to 40,000 readings, secondary parameter of 0.0001 reading resolution, maximum measuring frequency up to 100kHz, constant internal resistance of 100  $\Omega$  and three optional testing levels. The auto range can rapidly display the measuring results and automatically choose the desirable testing parameters in accordance with components properties. Its measuring accuracy is unimaginable up to 0.1%.

Front panel push buttons maximize the convenience of function, such as FREQ, LEV, TOL and RATE. Tolerance mode can sort components, record mode aid to capture readings, convenient open/short clear function improve the measuring accuracy, utility menu

---

help you easily take the selections of the key tone, auto power-off and storage.

ST2822D/E is equipped with the function of remote communication. The test data can be transferred to PC through a Mini USB connection, great for applications that require remote control and data acquisition.

## Package List

ST2822D/E is equipped with the following contents:

- ST2822D/ST2822E handheld LCR meter
- Instruction manual
- Mini USB Interface Cable
- Red / Black Banana plugs—Crocodile clip Test Leads
- Short-circuit plate
- 8.4V rechargeable battery
- \*AC adapter
- \*ST26027A Kelvin clip test leads
- \* ST26009C SMD test tweezers
- \*ST26029C SMD test tweezers

---

*\* This can be purchased as optional accessories. All contents are subject to actual package list or box.*

Please locate them from the original packaging to ensure nothing is missing. If in the case that an item is missing, please contact Sourcetric or relevant distributor immediately.

# Front Panel Overview

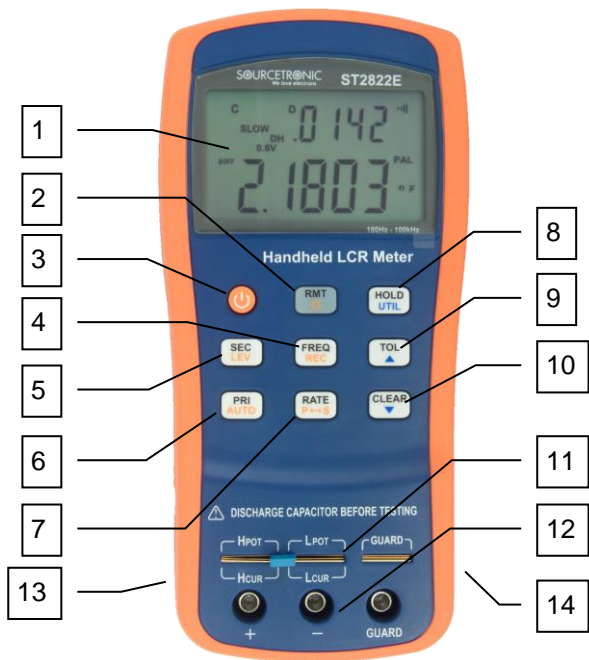

Figure 1 - Front Panel Display (model ST2822E shown)

---

## Front Panel Display Descriptions

1. LCD display
2. USB communication / \*Back light button
3. Power ON/OFF button
4. Frequency and record mode selection
5. Secondary display mode (D/Q/ $\theta$ /ESR, etc.)/  
Test Level
6. Primary display mode (L/C/R/Z/DCR, etc.)/  
auto LCR selection
7. Rate/equivalent mode selection
8. Hold mode/ utility menu
9. Tolerance mode/ utility arrow key
10. Open/short clear/ utility arrow key
11. 5-terminal test sockets (direct measurement  
on lead components or use of test fixture)
12. 3-terminal test jacks (for use of Banana plugs  
- Crocodile clip Test Leads)
13. Standard mini USB port (for remote control)
14. 12VDC external power input (use with an  
external power adapter)

*NOTE: Refer to the adapter's label for input parameters of it. Rated output parameter: 12VDC, 150mA, 4mm.*

---

*NOTE: Use with included power adapter only or purchase the specified adapters from Sourcetric. Use with improper power adapters may damage instrument.*

**NOTE:** *Internal battery supply will be automatically cut off when external power is connected. If the battery is rechargeable (ST2822D/E), the external power will charge the battery simultaneously. ST2822D/E is equipped with an independent charging controller - charging control is still done even at the state of power-off.*

**WARNING:** Before connecting an external power adapter, be sure that the polarity matches the (+) and (-) labels as indicated inside the battery compartment. If it is not installed correctly and connected to an external power adapter, it might cause severe damage to the instrument.

**WARNING:** If the instrument can charge the battery (ST2822D/E), please be sure that the polarity matches the (+) and (-) labels as indicated inside the battery compartment and the battery is rechargeable. **DO NOT** charge a non-rechargeable battery!

---

## Front Panel Buttons

With the exception of the power button, all front panel buttons have specific colored labels on them. They are all marked in black, blue or orange color. Each color has a specific representation, as described below:

**Black**—the primary function, meaning that function will be set or configured upon pressing it.

**Orange**—the secondary function, it means that the function will be set or configured if that button is pressed and hold down for 2 seconds.

**Blue**—the utility function, the function will be set or configured if the **UTIL** button is pressed and hold down for a long time. See “Utility Menu” section for details.

**NOTE:** *In the button operational instruction, we will use the button name to express the button operation without differentiating the type of button; Pay attention to the difference between “long press” and “press”.*



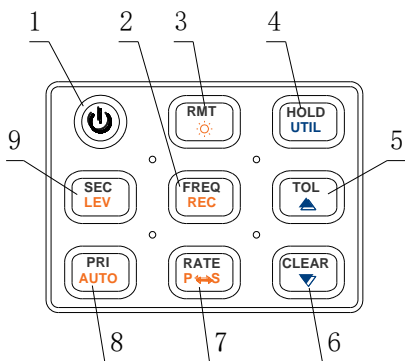

**Figure 2 - Button Display**

### **Button Function Definition**

1. Power ON/OFF Button
2. Frequency/Record Mode Button
3. Remote Control/Backlight Button
4. Readings Hold/Utility Menu Button
5. Tolerance mode/ Menu Selection Button
6. Clear/ Menu Selection Button
7. Rate/Equivalent Mode Button
8. LCR Primary Parameters/Auto LCR
9. Secondary Parameters Selection Button/LEV

---



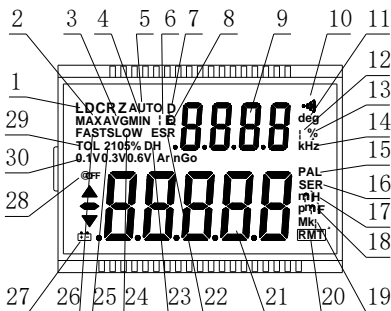



## LCD Display Overview



**Figure 3 - LCD Indicator Display**

## LCD Display Description

1. LDCRZ – Primary parameters display
2. MAX – Maximum reading indicator in the record mode

- 
3. AVG – Average reading indicator in the record mode
  4. MIN – Minimum reading indicator in the record mode
  5. AUTO – Automatic LCR indicator
  6.  $\theta$  – Phase angle indicator for secondary display
  7. D – Dissipation indicator
  8. Q – Quality factor indicator
  9.  – Secondary parameter display
  10.  – Beeper tone indicator for tolerance mode
  11. deg – Phase angle ( $\theta$ ) units indicator
  12.  $\Omega$  – ESR(ohm) units indicator
  13. % - Percentage indicator (in tolerance mode)
  14. kHz – Frequency units indicator
  15. PAL – Parallel mode indicator
  16. SER – Series mode indicator
  17.  – Inductance units (L) indicator
  18.  –Capacitance units (C) indicator
  19. Mk $\Omega$  – Resistance(R) /impedance units indicator
  20.  – Remote mode indicator
  21.  – Primary parameter display

- 
22. ESR – Series mode indicator for secondary parameters
  23. DH – Data hold indicator
  24. SLOW – measuring rate indicator
  25. 2105% - Limits indicator in tolerance mode
  26. FAST- Fast measuring rate indicator
  27.  – Low battery/charging indicator
  28. @OFF –Auto power-off indicator
  29. TOL –Tolerance mode indicator
  30. 1V 0.6V 0.3V- Display test level

---

## Special Display Indicators

SHrE Indicates short clear if you press the CLEAR button

OPEn Indicates open clear if you press the CLEAR button

Err Error indication

CAL mode Indicates correction (open/short clear)

FUSE Indicates damaged or open fuse

EO1 (UNK)AD converter error(UNK)

EO2 AD converter error(END)

---

## Test Port

ST2822 series are creatively designed to combine 3-terminal port and 5-terminal port, which makes highly accurate testing conveniently realized in the instrument.

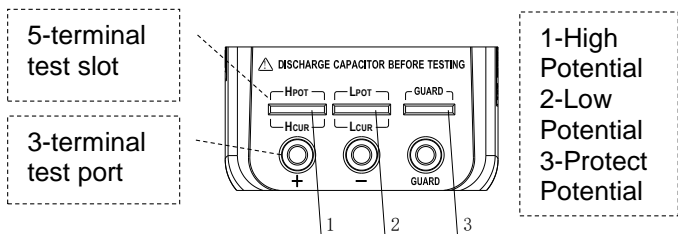

**Figure 4- test port**

With the adoption of standard banana slots, the instrument can use inexpensive banana plug-crocodile clips as the test leads, which makes the test

---

quite convenient. However this configuration has low testing accuracy especially when the DUT has low impedance.

For the improvement of accuracy when using external testing leads, ST2822 series are designed with 5-terminal testing slots and exclusive test fixture to ensure complete external 4-terminal test and measuring accuracy.

**NOTE:** *ST26027A, ST26009C and ST26029C 4-terminal test fixtures are optional for ST2822 series. Please refer to relevant instrument accessories.*

## Powering Instrument

There are two methods to power the instrument: Battery and external power adapter. When the two power modes are available, the external source is prior to the battery. The two power modes can be automatically shifted without interruption.

---

## Installing Battery

ST2822D/E can adopt battery for power supply so that you can take measurements whenever and wherever without much preparation.

**8.4V alkaline batteries used in ST2822D/E are rechargeable. Reference standard is LH-200H7C. Do not use non-rechargeable batteries with the exception of emergency cases. The reason is that the charging circuit will operate once the instrument is connected to external source.**

To Install the Battery:

1. Open up the back-flip stand, and locate the screw that tightens the battery compartment cover as indicated in Figure 5. Use a screwdriver to unscrew and remove the cover.
2. Insert proper battery into compartment. Note the positive (+) and negative (-) terminals as indicated inside the battery compartment



- 
- (See Figure 6). Be sure to insert the battery with matching polarity.
3. Place the battery compartment cover piece by sliding it into the top slid first. Place screw at the bottom of the cover piece and tighten down with a screw driver.
  4. Push and hold down the power ON/OFF button for 2 seconds to turn on the instrument.



**Figure 5- Back Cover**

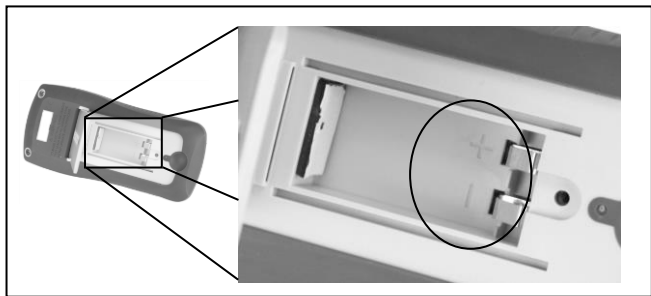

**Figure 6- Battery Compartment**

## **Connecting External Power Source**

ST2822D/E is equipped with standard external power adapters, which can use external source.

---

**WARNING: Use the included or specified adapter only. Confirm power parameters be ones that adapters require before use.**

To connect the adapter, do the following:

1. If a battery is installed, please check the battery compartment again that the polarity of the battery matches the polarity as indicated by the labels inside the compartment.

**WARNING: DO NOT, at any time, connect an external power adapter when a battery is installed incorrectly or a non-rechargeable battery is inserted in a rechargeable instrument. Doing so will damage the instrument and void its warranty.**

2. Confirm that an appropriate power supply connects to the adapter.
3. Connect the AC adapter connector into the right side jack of 12VDC.
4. Connect the AC Adapter socket into an electrical outlet.
5. Press and hold down the power button for about 2s to turn on the meter.

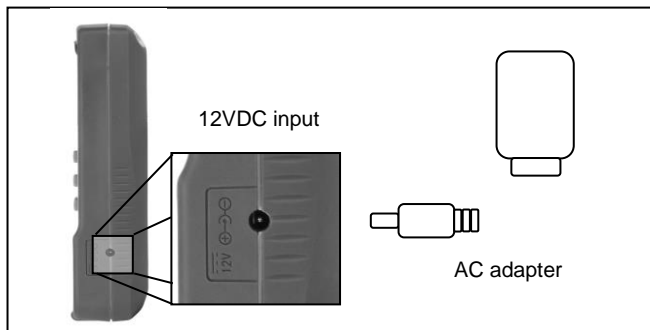

**Figure 7-Connecting AC Adapter to Meter**



NOTE: The meter will automatically switch to consume power from the AC adapter instead of the battery when an AC adapter is plugged in and consume the power normally. In this event, if the battery installed correctly is rechargeable, charging controller will be driven at the same time no matter the instrument is on or off.

## **Low Battery Indication**

At the use of battery for power supply, if the display starts flashing the  indicator, it means that the

---

battery voltage is below normal working voltage (below 6.8V). It is highly recommended that the battery be replaced as soon as possible before continuing operation. See “Installing Battery” for instructions.

If the battery is rechargeable, when the  indicator starts flashing, please charge the battery before continuing operation. When the external source is plugged in, the flash of RMT/ indicator indicates the charging state.

## Backlight Display

In the case of lacking light, turn on the back light to help read the data.

To turn on the back light, you should press the  button for 2 seconds.

To turn off the back light, you should press the  button for 2 seconds.

---

### ***When Using Battery Power***

When the meter is powered by using battery, the brightness of the back light will automatically decrease to conserve battery power. When the back light have lightened for about 15 seconds, the brightness will continuously decrease; and when the back light have lightened for approximate 30 seconds, the back light will automatically turn off.

### ***When Using External Power***

When the meter is powered using an external AC adapter, once the back light is turned on, it will stay at its maximum brightness continuously and will not automatically turn off. Unplugging the external power to use battery power, the back light will decrease its brightness and automatically turn off.

---



## Charge Display

The power circuit of ST2822D/E is rechargeable. When the external power adapter is plugged in, the power mode will automatically switched and charge the internal chargeable battery.

Single charge circle is about 160 minutes and charge current is approximate 120mA. If a battery is full charged, the charge will be automatically shut off; instead, the battery will be charged again after a charge circle.

**NOTE:** *A new charge circle will begin as soon as an external power is connected.*

**WARNING:** **If the instrument has rechargeable circuit, DO NOT connect to an external power when a non-rechargeable battery is installed. Doing so will cause the burst of the battery.**

 : It indicates low power of a battery before the connection of external power; after the connection, it means the charging state. RMT/

---

indicator will be light up in the condition of being charged no matter the instrument is off or on.



---

# Operation Instruction

## Data hold mode (HOLD)

The data hold function allows the user to freeze the display data. The data displayed on LCD will not be updated upon the phase of test.

### *Turn On Data Hold*

To use data hold, press the **HOLD** button. The “DH” indicator will display on the screen when data hold is active. At this moment, primary and secondary displayed on LCD is the testing result before the press of **HOLD** button.

---

## ***Turn Off Data Hold***

To disable the data hold, press the **HOLD** button again. The “DH” indicator will disappear on the screen, and meter will remain in normal operation mode.

## **Data Record Mode (REC)**

If the data stability of tested components is poor and the data fluctuates in a range, data record mode can aid the reading of data.

This mode is used for dynamically recording maximum, minimum, and average values in a range.

## ***Enable Static Recording***

Press and hold down the **REC** button for a long time to enter the data recording mode. The display should indicate “MAX AVG MIN” simultaneously, which indicates the meter is in static recording mode.

---

## ***Using Static Recording***

There are four different modes that can be selected in static recording. Per press of the REC button (in recording mode, FREQ will disable), the modes will change and repeat in the following order:

**Recording mode → Maximum Mode → Minimum Mode → Average Mode**

### **Recording State**

This is the default mode when enabling static recording. In this mode, LCD will display “MAX AVG MIN” indicator. In a relatively stable range of test data, a beep tone will sound once a recording has been stored.

**NOTE:** *When the data fluctuation range is upwards of 1%, data record will dynamically be refreshed.*

---

### Maximum Display

Press **REC** button until the “MAX” indicator is shown on display. This indicates that the value in the primary display represents the recorded maximum value.

### Minimum Display

Press **REC** button until the “MIN” indicator is shown on display. This indicates that the value in the primary display represents the recorded minimum value.

### Average Display

Press **REC** button until the “AVG” indicator is shown on display. This indicates that the value in the primary display represents the recorded average value.

---

## ***Disable Static Recording***

To exit this mode, press and hold the REC button for a long time. The “MAX”, “MIN”, or “AVG” indicator will disappear on LCD.

***NOTE:*** *Changing the type of test parameters will automatically turn off static recording.*

## **PRI Select Mode**

To select measurement mode, you should select primary parameter first.

Each press of the **PRI** button, the parameter will change and repeat as the following modes: L (inductance), C (capacitance), R (resistance), Z (impedance) and DCR (direct current resistance).

***NOTE:*** *After changing primary parameter, secondary display indicates the present frequency. No secondary parameter display in DCR state. If it is required to display corresponding secondary parameters, press the secondary button.*

---

## SEC Select Mode

If necessary, press the **SEC** button to select secondary parameters.

Each press of the **SEC** button, the following modes will be displayed on the screen: D (Dissipation factor), Q (Quality factor),  $\theta$  (Phase angle), and ESR (Equivalent series resistance).

## Test Frequency (FREQ)

ST2822D/E handheld LCR meters apply AC signal to DUT for measurement. Frequency is among the main parameters of AC signal. By the presence of component's non-ideality and distributed parameters, the effect of distributed parameters of test port and test lead, the test frequency used on the same component might cause different test result. Therefore, a proper frequency should be selected before test.

---

## **Selecting Frequency**

To change the test frequency, push the **FREQ** button. If the secondary display does not indicate the frequency, it will display the actual operating frequency when you press **FREQ**. If the secondary display indicates frequency, at each press of the **FREQ** button, the meter will change among the following selectable frequencies:

ST2822D:100Hz/120Hz/1kHz/10kHz

ST2822E:100Hz/120Hz/1kHz/10kHz/100kHz

## **Test Electric Level**

ST2822D/E handheld LCR Meter uses AC signal applied to the item measured (DUT) to test. The level is the amplitude of the AC signal, due to the level sensitivity of some component, the same component using different levels may have different test results. Therefore, a suitable test level should be selected before measurement. Long press LEV button, the instrument can switch the level between 0.6V, 0.3V and 1V.

---

## Tolerance Mode (TOL)

The tolerance mode is specifically used for component sorting purposes. In tolerance mode, secondary display indicates the range of percentage.

Tolerance mode, nominal value and sorting limit just come into play on primary parameters. The selectable range for sorting is as follows: 1%, 5%, 10%, 20%.

In tolerance mode, the data indicated in the primary display will be recorded as nominal value.

Displayed value in percentage:

$$=100*(Mx-Nom)/Nom\%$$

Where, Mx: the primary parameter display;

Nom: the nominal value recorded.

The percentage value is used for sorting.



---

## ***Use Tolerance Mode***

To use the tolerance mode as the process shown below:

1. Select the desired primary measurement mode by pressing **PRI** button.
2. Configure the proper test frequency and series/parallel equivalent mode.
3. Perform the operation of CLEAR appropriately if necessary.
4. Test standard implements or components with accurate and reliable measured value.
5. Once the desired measured reading is displayed, press the **TOL** button once to store the reading as the nominal value. At this point, the “TOL” will be displayed on the screen, indicating that the tolerance mode is activated. A percentage mode will be shown in the secondary mode to indicate the percentage range.

**NOTE:** Before the press of **TOL** button, the primary parameter indicated on LCD in any mode can be taken as the nominal value,

---

*including data hold, MAX, MIN, AVG data recording, etc.*

6. If sorting is not necessary, you can skip this step. If it is necessary, by pressing the **TOL** button you can select the range of 1%, 5%, 10% or 20%, which will be shown on LCD accordingly.
7. Changing test component, an audible tone will be heard. One single “beep” or tone means the component is within tolerance. Three “beeps” or tone means the component is out of tolerance.

**WARNING:** Be sure that the capacitor has been fully discharged before its test, or the instrument might be damaged.

### ***Disable Tolerance Mode***

Long press of **TOL** button will disable tolerance mode.

**NOTE:** *Changing the test frequency, primary function, or secondary function will automatically disable tolerance mode.*

---

## **Auto LCR Mode**

Auto LCR function will automatically select the corresponding primary and secondary parameters and suitable series/parallel equivalent mode of L, C, R. The selection is done by judging the impedance property of component according to the test result. It is quite convenient for the measurements of mixed and unknown components.

### ***Enable Auto LCR Mode***

Long press of AUTO button will activate auto LCR mode. The “AUTO” indicator on LCD indicates that auto LCR mode is activated.

In auto LCR mode, the match of secondary parameter with primary parameter is shown as below:

---

**Table1-Matching relations between primary and secondary parameters in auto LCR mode**

<b>Primary Parameter</b>	<b>Secondary Parameter</b>
Capacitance (C)	Dissipation (D)
Inductance (L)	Quality Factor (Q)
Resistance (R)	Phase Angle ( $\theta$ )

In auto LCR mode, series or parallel equivalent mode is selected in accordance with the magnitude of impedance. Parallel mode is selected at high impedance and series mode at low impedance.

### ***Disable Auto LCR Mode***

Long press the **AUTO** button again will disable auto LCR mode. In addition, this mode will not continue through changing the primary and secondary modes, series/parallel equivalent mode and frequency mode.

---

“AUTO” indicator on LCD will disappear when auto LCR mode is turned off.

## **Measurement Rate (RATE)**

There are two selectable measurement rates in this instrument: fast and slow. The rate of fast measurement is about 4~5times/sec and slow measurement is approximate 1.5 times/sec. The stability of slow measurement is higher than fast measurement.

The fast and slow rates can be directly switched by pressing **RATE** button. “FAST” indicator will be displayed on LCD at fast rate and “ SLOW ” indicator at slow rate.

## **Series/parallel Equivalent Mode**

For the presence of non-ideality and distributed parameters of components, actual components are

frequently taken as combined network of ideal components. In general, there are two simple equivalent models used in LCR meters, which are series model and parallel model.

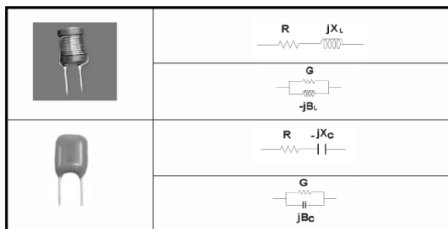

**Figure 8-Series and Parallel Equivalent Models of Inductors and Capacitors**

Appropriate equivalent modes could help to gain better measurement results. Generally, Series mode is better for components with low impedance (below  $100\ \Omega$ ), while parallel mode for components with high impedance (over  $10\text{k}\ \Omega$ ). For the components with the impedance between the two limits, equivalent mode has little effect on the testing result.

---

## ***Selecting Measurement Mode***

Long press **P<->S** button, “PAL” on LCD indicates parallel equivalent mode and “SER” means series equivalent mode.

## ***Default Equivalent Mode***



In this mode, default equivalent mode varies with primary parameter:

For capacitors and resistors, default equivalent mode is PAL; for inductors, SER.

## **Utility Menu (UTIL)**

The LCR meter has a built-in utility menu that allows you to configure some user preferences and settings. The buttons used to set and control the menu are

---

colored in blue. There are three buttons: **UTIL**, , . User can configure the beep tone, auto power-off timing, store/restore power-on state, view the battery voltage, etc.

### ***Entering Utility Menu***

Long press **UTIL** button will enter utility menu. Primary display is menu option and secondary display is the current settings or parameters configured for the selected option. After the entrance into utility menu, the default menu item display will show “bEEP” .

### ***Configuration and Settings***

The following contents are included in the utility menu:



---

**Table 2-Utility Menu Options and Settings**

<b>Menu Options</b>	<b>Settings/Parameters</b>
dCdly	DCR trigger delay
'bBEEP	ON / OFF
AoFF	5 / 15 / 30 / 60 / OFF
PuP	PrE / Set
dEF	yES / NO
bAtt	Battery Voltage

Uses of these menu options are as follows:

DCR trigger delay function: (dCdLy: DCR delay)

Control beep sound: ( bBEEP: beep sound);

Set auto power-off: (AoFF: auto power off);

Set power-up state: (PuP: power-up state);

Reset to default settings: (dEF: default settings);

Indicate battery voltage: (bAtt: battery voltage).

By default, press the button **UTIL** to change or select a different menu option. To change the settings or parameters, use the **▲** and **▼** arrow keys. For each UTIL button press, the meter will traverse through

---

each menu options and will repeat itself in the following order:

**dCdLy → bEEP → AoFF → PuP → dEF → bAtt**

**NOTE:** *The change of settings has different application effects in accordance with different exiting mode. See “Exit Utility Menu” section (Saving and Exiting, Exiting without Saving) for details.*

### DCR Trigger delay Setup (dCdLy)

The “dCdLy” menu option is used to set the trigger delay time ranging from 0000 to 9999ms.

Using the  and  arrow keys to add or minus the time by 1. Long time pressing  and  arrow keys can move the current cursor to left or right. The setup is promptly effective once modified.

**NOTE:** when the setting is not 0000, the higher the setting time, the DCR measurement speed becomes more slowly. It is suggested to set the time to 0000.

**Default setting: 0000**

---

### Beep Sound Setup (bEEP)

The “bEEP” menu option allows the user to enable or disable the beep sound for every key press.

**NOTE:** This option only disables the beep sound for each key press. It does not disable the beep sound for “Tolerance” mode and “Static Recording”, as well as the “auto power-off” warning.

Using the ▲ and ▼ arrow keys to choose ON or OFF. This setting will be immediately effective. But this state will not be saved if choose “Exiting without Saving”; “Saving and Exiting” should be implemented if this setting needs to be effective after restarting.

Default setting: ON.

### Auto power-off Setup(AoFF)

The “AoFF” menu option allows the user to select the auto power-off timer. The available timer settings are: 5min/15min/30min/60min/OFF. When the primary

---

display shows “AoFF” , push the ▲ and ▼ arrow keys to select the timer setting. The settings will be shown on the secondary display as Table 3.

When AoFF is effective, this timer is always counting continuously; when the configured time is up, the meter will make an audible “ beep ” sound continuously to remind the user of prompt auto power-off. Before auto power-off, pressing any button will reset the timer count.

*NOTE: Auto power-off is effective only for battery power.*

*NOTE: When auto power-off is efficient, the display of “@OFF” indicates the operation of timer.*

*NOTE: Auto power-off will not work temporarily in TOL mode, REC mode and RMT mode. It will be activated after exiting of above modes.*

**Table 3- Auto Power-off Options**

<b>Secondary Display</b>	<b>Representation</b>
5	5 minutes
15	15 minutes
30	30 minutes

---

60	60 minutes
OFF	Manual power off only

The setting will be immediately effective. But this state will not be saved if you choose “Exiting without saving” ; “Saving and exiting” should be implemented if this setting needs to be effective after restarting.



Default Setting: 5

### Power-up State (PuP)

The “PuP” menu option allows user to configure the power-up state of the LCR meter, allowing user to restore settings saved into internal EEPROM memory at power-up. The storable settings are as follows:

- Primary function mode (e.g. L/C/R)
- Secondary function mode (e.g. D/Q)
- Auto LCR
- Series/parallel equivalent mode
- Test frequency
- Tolerance mode

- 
- Reference value for Tolerance mode
  - Measurement rate

In the utility menu, Press the  and  arrow keys to select “PrE” or “SEt”. PrE means to preserve the previous setting while SEt means to save the current parameter, that is, cover the original data.

***NOTE:*** *Exiting mode decides whether to implement SEt. At “Exiting without saving”, SEt is ineffective; while at “Saving and Exiting”, SEt setting will be effective.*

*Default Setting: PrE*

## **Configure and Save Power-up State**

Procedure to configure and save power-up state is as follows:

1. Before entering into the utility menu, configure all the measurement parameters firstly, such as frequency, primary and secondary parameters. If the meter is currently in the

- 
- utility menu, exit first and enter into utility menu after measuring setup.
2. Press **UTIL** button for a long time to enter into utility menu.
  3. Push the **UTIL** button to traverse through the utility menu until you see “PuP” on the primary display.
  4. In order to save the current meter settings for power-up state into internal memory, use either **▲** or **▼** button to change the settings so that the secondary display shows “SEt” .
  5. Press the **UTIL** button to check whether all desirable setups have already be set. With all settings done, exit the menu by long press of the **UTIL** button.
  6. The meter has now saved all current settings into internal memory. At next power-up, the meter will turn on and recall the saved settings.

**NOTE:** *The meter allows one set of settings to be stored into memory. Therefore, the same procedure is used to overwrite previously stored settings into memory.*

---

## Prevent Overwrite of Stored Settings

In the utility menu, the “PuP” option default setting is always “PrE” . If it is required to overwrite previously stored settings for power-up state, the option should change to “SEt” . Therefore, when entering the utility menu, be sure not to change to “SEt” to prevent overwriting any previously stored power-up settings.

### Reset Default Settings (dEF)

The “dEF” option is used to reset the current measuring setup and optional settings in utility menu to default settings. These default settings are as below:



---

## **Table 4 - Instrument Default Settings**

---

Settings	Default Configuration
Primary Function	C (capacitance)
Secondary Function	None (frequency)
Auto LCR function	Off
Equivalent Method	SER (series)
Measurement Frequency	1kHz
Measurement Level	0.6V
Measurement Speed	Slow (SLOW)
Tolerance Mode	Off
Beep Sound	On
Auto Power-off Timing	5 minutes
Stored Measurement Setup	clear
Stored Utility Menu Option	clear

---

In “dEF” option, push either  or  button to choose “NO” or “yES” . “NO” means the instrument will not be set back to default. “yES” indicates to reset all settings to default and to clear previously stored setup.

*Default Setting: No*

**NOTE:** *Exiting mode also decides whether or not to perform “yES” function. At the use of “exiting without saving”, “yES” is ineffective; when “saving and exiting” is selected, restore operation will be efficient.*

**NOTE:** *In the case where under “PuP” option, “SEt” is selected and “dEF” is set to “yES”, the “PuP” setting has priority over the “dEF” setting. This means the instrument will not be set back to default upon saving and exiting the utility menu. Instead, the power-up settings will be stored and will be recalled upon the next power-up of the instrument.*

---

### Indicate battery voltage(bAtt)

When menu option changes to “ bAtt ” , the secondary display will indicate battery voltage that is for reference instead of for operational function.

### ***Exit Utility Menu***

There are two methods for exiting the utility menu: **Saving and Exiting, Exiting without Saving**. The former saves all the changed settings before exiting, and the latter exits the menu without saving any changes.

### Saving and Exiting

To save all utility menu option settings and to exit the menu, press and hold down the **UTIL** button for a long time. After this, the meter will exit the menu. Then PuP and dEF will be performed and all settings will be saved.

---

“Saving” refers to preserve corresponding information in the built-in non-volatile memory. Therefore, data will not lose at the time of power-off and can be used at the time of power-on.

### Exiting Without Saving

If user decides to exit the utility menu without making any changes or saving any changes to “PuP” or “dEF” , it can be done by simply pressing any front panel buttons except **UTIL**, **▲**, **▼** and **POWER**. PuP and dEF operation will be ineffective. Settings, such as “bEEP” and “AoFF” will not saved in non-volatile memory but still be temporarily efficient until the next power-up of the instrument.

---

## Clear Functions (CLEAR)

There are two functions under CLEAR: Open Clear and Short Clear. Clear can decrease the distributed error caused by test leads, for instance, short clear can reduce the effects of contact resistors and test leads and open clear will minimize the influence of distributed capacitors and resistors on testing high impedance elements.

### *Enter Clear Mode*

For convenience, open clear and short clear are designed to share a button. By pressing the CLEAR button, the meter will automatically choose either open clear or close clear.

---

## Open Clear

First select frequency to clear and keep test clip and test slot be open. Enter into clear by the press of **CLEAR**, and a moment later the OPEN indicator will appear on secondary display after the automatic measurement judging. If user decides to perform open clear, another press of **CLEAR** should be done.

**NOTE:** “----” indicator on secondary display indicates that test terminal is out of open state and open clear cannot be performed.

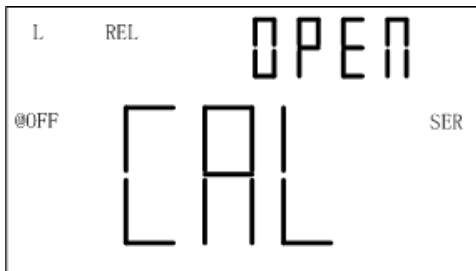

Figure 9 - Open Clear

---

## **Short Clear**

First choose test frequency to clear and then insert a short plate to test slot. If SMD test tweezers or test clip is used, the short plate should cut off the test terminal. Enter into clear by the press of **CLEAR**, and a moment later the SHrT indicator will appear on secondary display after the automatic measurement judging. If user decides to perform short clear, another press of **CLEAR** should be done.

**NOTE:** “----” indicator on secondary display indicates that test terminal is out of short state and short clear cannot be performed.



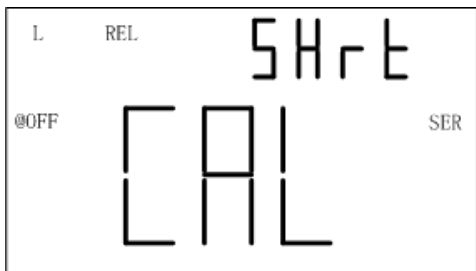

Figure10-Short Clear

### ***Quick Clear Procedure***

Below is an example of steps to follow to do open or short clear:

1. Select the primary and secondary function mode for measurement;
2. Select test frequency;
3. Select equivalent mode;
4. Keep the test terminal open to perform open clear;
5. Short the test terminal to perform short clear;
6. Connect DUT to start testing after clear.

---

**NOTE:**

1. *Clear data is just temporarily stored in RAM, which means that the data will loss after power-off. Therefore “ clear ” , prior to measurement, should be first done after power-on.*
2. *Clear data is stored under different frequency, thus they will be still valid at the change of test frequency (for instance, under the frequency of 1kHz, the meter has been cleared; and when the frequency is back to 1kHz, there is no need to clear again.)*
3. *Clear is not concerned with test parameters and series/parallel equivalent mode. In accordance with developed impedance network principle, the instrument performs clear operation. Though the complex impedance is cleared, parameter is just the element after the change of impedance.*
4. *After a long time of continuous use, the meter will be affected by the temperature environment and test fixtures, test leads and contact resistance will change. It should be necessary to clear once more according to specific conditions so as to meet the requirement of accuracy.*

---

## **Remote Control (RMT)**

When the RMT button is used for remote communication, please see “REMOTE COMMUNICATION” section for details.

## **Fuse Detection**

The meter has an internal fuse in the test signal terminal that protects the inputs from severely damaging the instrument. When the fuse is burned out, the “FUSE” indicator will appear on the primary display and an internal “beep” will sound continuously. In this situation, none of the function buttons can be operated and all other meter functions will be disabled.



**Figure 11-Fuse Display**

In the event that the above screen is displayed, the instrument should be powered off. If this does not power off the meter, remove external AC adapter if that is used and/or remove the battery from the battery compartment. Please contact after-sale department of our company or appointed distributor for the change of fuse or maintenance.

***NOTE:*** Both element damage and none output of test signal caused by signal source fault will make “FUSE” alarm.

---

# Quick Start Guide

## CAUTION

- Do not measure a capacitor that is not fully discharged. Connecting a charged or partially charged capacitor to the input terminals will damage the instrument.
- When measuring an on-board component within a circuit, the circuit must be powered off before connecting the test leads.
- When used in a dusty environment, the instrument should be wiped and cleaned regularly. The electrical conductivity carried by the accumulated dust will eventually have an effect on the use of the meter.
- Do not leave the instrument exposed to explosive, direct heated and overheating environments.

- 
- Before removing the cover, ensure that none DUT is connected to the meter and the instrument is disconnected from any circuit and is powered OFF.

**NOTE:** *To achieve optimum precision, please see “Clear Function ” for details before testing.*

## Inductance Measurement

1. Press the **POWER** button for a long time to turn on the instrument.
2. Press the **PRI** button until “L” is displayed on the screen to select inductance measurement
3. Insert an inductor into test slots or connect a tested inductor through a proper test accessory (e.g., banana plug-crocodile clip test leads, test fixture or SMD test tweezers). See figures 12 below. Figure 13 shows the optional 4-terminal test accessories.

4. Press the **FREQ** button until the desired test frequency is displayed on screen.
5. Press the **LEV** button until the desired test level is displayed on screen.
6. Press the **SEC** button to select the desired secondary parameter.
7. Read the readings on LCD for inductance measured values.

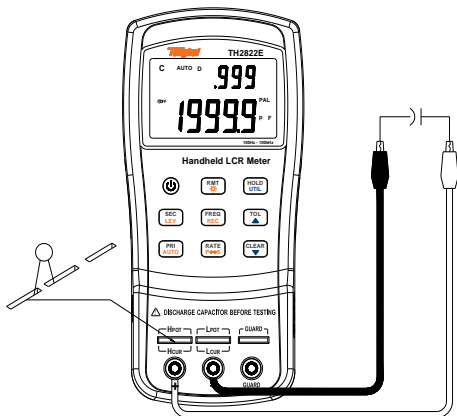

**Figure 12- Inductance Measurement**

---

Below are ST26027A, ST26009C and ST26029C 4-terminal test accessories:

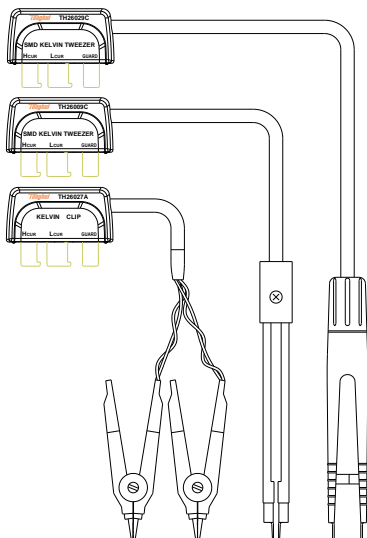

**Figure 13- 4-terminal Test Accessories**



---

## Capacitance Measurement

 **WARNING:** Before testing, ensure that the tested capacitor has been fully discharged.

1. Press the **POWER** button for a long time to turn on the meter.
2. Press the **PRI** button until “C” is displayed on the screen to select capacitance measurement.
3. Insert a capacitor into test slots or connect a tested capacitor through a proper test accessory (e.g., banana plug-crocodile clip test leads, test fixture or SMD test tweezers). See figures 14 below. Figure 13 shows the optional 4-terminal test accessories.
4. **CAUTION: BEFORE** inserting a capacitor or capacitive component into the input slots or terminals, be sure to fully discharge the component. Some larger capacitive

---

**components may take longer to discharge. In these cases, please allot enough time for a full discharge. If proper discharging of the component is not done correctly, it will damage the input terminals of the meter.**

5. Press the **FREQ** button until the desired test frequency is displayed on screen.
6. Press the **LEV** button until the desired test level is displayed on screen.
7. Press the **SEC** button to select the desired secondary parameter.
8. Read the readings on LCD for capacitance measured values.

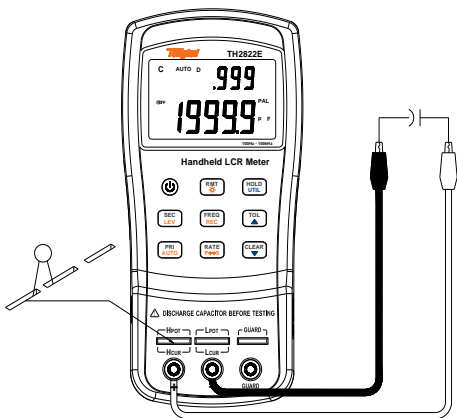

**Figure 14- Capacitance Measurement**

## Resistance Measurement

1. Press the **POWER** button for a long time to turn on the instrument.
2. Press the **RPI** button until “R” is displayed on the screen to select inductance measurement.

- 
3. Insert a resistor into test slots or connect a tested resistor through a proper test accessory (e.g., banana plug-crocodile clip test leads, test fixture or SMD test tweezers). See figures 15 below. Figure 13 shows the optional 4-terminal test accessories.
  4. Press the **FREQ** button until the desired test frequency is displayed on screen.
  5. Press the **LEV** button until the desired test level is displayed on screen.
  6. Press the **SEC** button to select the desired secondary parameter.
  7. Read the readings on LCD for resistance measured values.

**NOTE:** *The meter uses an AC signal for measurement of resistance, so what the test result shows is AC resistance property instead of DC resistance property.*

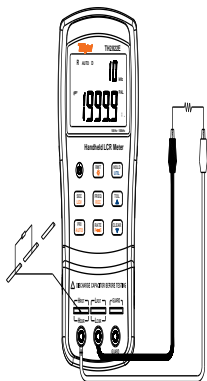

**Figure 15- Resistance Measurement**

---

## Impedance Measurement

1. Press the **POWER** button for a long time to turn on the instrument.
2. Press the **PRI** button until “Z” is displayed on the screen to select impedance measurement.
3. Insert impedance (resistor, capacitor or inductor) into test slots or connect tested impedance through a proper test accessory (i.e., banana plug-crocodile clip test leads, test fixture or SMD test tweezers).
4. Press the **FREQ** button until the desired test frequency is displayed on screen.
5. Press the **LEV** button until the desired test level is displayed on screen.
6. Press the **SEC** button to select the desired secondary parameter.
7. Read the readings on LCD for impedance measured values.

---

## Direct Current Resistance Measurement

1. Press the **POWER** button for a long time to turn on the instrument.
2. Press the **PR|** button until “DCR” is displayed on the screen to select direct current resistance measurement.
3. Insert impedance (resistor, capacitor or inductor) into test slots or connect tested impedance through a proper test accessory (i.e., banana plug-crocodile clip test leads, test fixture or SMD test tweezers).
4. Read the readings on LCD for impedance measured values.

## Remote Communication

The meter has the capability to communicate with a PC over the mini USB interface. Upon installation of a

---

USB driver, PC can control the instrument and collect test results over virtual serial interface.

## Connecting Instrument to PC

Follow the below procedures for connection setup.

1. Install USB driver from CD or download the USB drivers from [www.sourcetronic.com](http://www.sourcetronic.com).
2. With a Mini-USB cable, connect one end of it to the LCR meter and the other end to an available USB port on PC. Press the **POWER** button to turn on the meter.
3. Skip the next process when the driver has been stalled.
4. When Windows recognize the USB connection, PC will prompt user to install driver. The following process is to cancel installation guide and directly run the setup program in the setup file.
5. When completed, Windows will create a virtual serial port and distribute a serial number. See Windows device manager for details.



- 
6. Open the control software and use the assigned serial number to communicate with the handheld LCR meter. Download the FastAccess PC communication software from our web site ([www.sourcetric.com](http://www.sourcetric.com)).

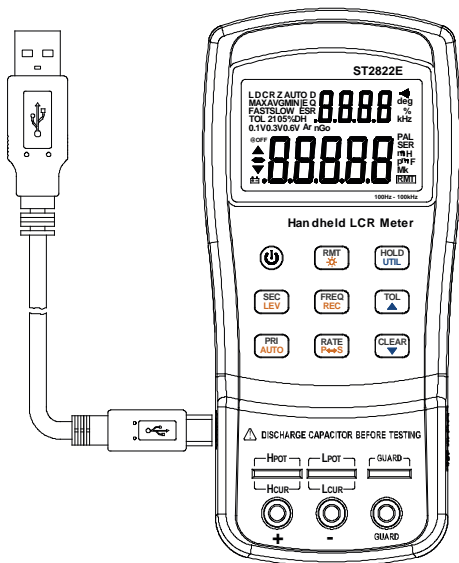

**Figure 16- Connection to PC**

---

## Virtual Serial Port Configuration

Below is the serial communication configuration of ST2822D/E:

- Baudrate: **9600**
- Data bits: **8**
- Parity: **None**
- Stop bits: **1**
- Flow Control: **None**

Upon the installation of USB driver, if the default assigned by serial port does not conform to above configuration, please modify it as the following process:

Open Windows device manager → Port → Corresponding Serial Interface → Right → Property → Port Setup

---

## RMT Operation

In the case of communication, the **RMT** button is used to change the running modes:

Change to Local Operation in Remote Control Mode;  
Change to Auto Fetch function in Local Operation mode.

**NOTE:** *Auto Fetch means to send testing result automatically without needing the initiative inquiry of PC.*

### **Remote Mode**

Upon the acceptance of any commands from PC, the meter will be automatically set into remote mode. In this mode, the LCD display will show “RMT” indicator. When this is shown, all front panel button will be locked and disabled, except for **RMT** and **POWER** buttons. If the meter has been in Auto Fetch mode before receiving remote control commands, Auto Fetch mode will be terminated.

---

That is to say, among panel operation, Auto Fetch and Remote Control, remote control has the highest priority.

To exit remote control, press the **RMT** button. When the “RMT” indicator disappears on the LCD display, the meter goes back to local operation.

**NOTE:** *If the local operation is locked, RMT button will be ineffective as well. See \*LLO Common Command in Command section for details.*

Out of remote mode, press RMT button to change to Auto Fetch. See the description below.

### ***Auto Fetch***

When the meter is out of remote control, it can be changed to Auto Fetch mode. That is, the meter will automatically send data to the interface bus upon every measurement. Therefore, PC will obtain data by direct reading with no need to send any commands. It is quite useful in the recording of simple data.

---

## Enable/Disable Auto Fetch

To toggle between enabling and disabling auto fetching when the meter is not under remote control, press the **RMT** button. In Auto Fetch, every flash of “RMT” means a measurement result is sent.

*NOTE: Auto Fetch can be disabled by remote control. When a remote command is sent to the meter, Auto Fetch will be disabled. To re-enable Auto Fetch after remote command, first press the **RMT** button to return panel operation and then enter into Auto Fetch mode by another press of **RMT**.*

## **Command Protocols**

### **Overview**

ST2822D/E employs SCPI commands with ASCII character strings transmitting control commands and

---

returning query information and data and with a specified terminator identifying the termination of a command line or query data line.

The adoption of SCPI commands brings convenience for the interaction control of PC on the meter through programming. Command format is compliance with specifications and easy for understanding and use.

### ***Common Command***

The IEEE 488 standard defines the common commands for general use in all kinds of instrument. Common commands usually come with the asterisk “\*” character, and may include parameters. Some examples of Common command like: \*IDN?, \*GTL, \*LLO. ST2822 series support a few common commands. See the following command descriptions for more details.

---

## ***Termination Character***

A terminator is a character sent by a host, which identifies the end of a command string. Only when a termination character is received, the instrument will analyze and deal with command character string. Terminators can be any one of the following character strings:

<CR> (Carriage Return, ASC(&H0D)) ;

<LF> (Line Feed, ASC(&H0A));

<CR><LF>

## ***Returned Result***

After the meter executes a query command, the return of the result will be in the following format:

<Result> + <CR> <LF>

CR is Carriage Return and LF, Line Feed.

For example, in inquiring measured results (FETCH?), the format of the printed data will be shown as the following:

---

**<Primary measured data, Secondary measured data, Tolerance Result> <CR> <LF>**

### ***Data Types***

Table 5 below explains the different data types transmitted on bus with ASCII characters:

**Table 5 - Data Type**

Data Type	Explanation	Example
<NR1>	Integer	+800,-200,100,-50
<NR2>	Integer	+1.56,-0.001,10.5
<NR3>	This representation has an explicit radix point and an exponent	+2.345678E+04 -1.345678E-01
<Boolean>	A parameter for Boolean setting. Always return "0" or "1" for Boolean query command	ON or OFF
<Literal>	A string is used as command parameters with short literal form	HOLD



---

## ***Symbol Convention***

### *Syntax Symbols in Commands*

Below symbols is a part of commands:

Syntax Symbol	Explanation
:	Colon means to enter into next command level
;	same command level
*	common command
,	multi-parameter delimiter
?	inquiry
	Space, separate commands from parameters
“ ”	quoting part

### *Command Specifier*

Below symbols are used for the description of command format, which are not the constituting part of command.

---

**Table 6-Command Specifier**

Mark Symbol	Explanation
[ ]	Option; can be omitted
	Exclusive OR
< >	Defined element
( )	Comment

*Abbreviation, upper case and lower case commands*

1. There are two command formats: complete format and abbreviated format. In the following command description, upper case commands are abbreviated commands. It has the same effect of sending abbreviated and complete commands.
2. Abbreviation command is generally shown in the form of 4-letter. Any abbreviation absent from command table is taken as incorrect command.

- 
3. It is not important to distinguish the real transmitted ASCII commands or parameter letters on bus.

## ***Command Reference***

### *Common Commands*

#### **\*IDN?**

Query instrument ID.

Return: <instrument model>, <firmware version>,  
<serial number>

#### **\*LLO**

Local Lockout. This means that all front panel buttons, including the RMT key is not available. (POWER button is enabled.)

---

### **\*GTL**

Go to local and remove local lockout. If \*LLO is sent, the only way to operate front panel is to go to \*GTL.

### **\*TRG**

Trigger the instrument to take a measurement. Due to the automatically continuous test, \*TRG command is of no use.

## SCPI Commands

### **FREQuency Subsystem commands**

#### **FREQuency <value>**

Description: Set the test frequency

Parameters: 100, 120, 1000, 10000, 100000 or 100Hz, 120Hz, 1kHz, 10kHz, 100kHz (model dependent)

Example: FREQuency 100Hz

Set the frequency to 100Hz

---

## **FREQuency?**

Description: Query the current test frequency

Return: <100Hz|120Hz|1kHz|10kHz|100kHz>

## **VOLTage subsystem**

### **VOLTage <value>**

Description: set the test level (only effective in L,C,R,Z)

Parameters are 0.3, 0.6, 1 or 3e-1,6e-1,1e0

Example: VOLTage 0.3

Set the test level to 0.3 V

## **VOLTage?**

Description: set the current test level

Return: <0.3V|0.6V|1V>

## **FUNCtion subsystem**

### **FUNCtion:impa < L | C | R | Z | DCR >**

Description: Select the primary parameter

Example: FUNCtion:impa L

Selects L as the primary parameter

### **FUNCtion:impa?**

Description: Query the primary parameter

Return: <L, C, R, Z, DCR, NULL >

---

### **FUNCTION:impb < D | Q | THETA | ESR >**

Description: Select the secondary parameter  
(only effective in L,C,R,Z)

Example: FUNCTION:impb D

Select D as the secondary parameter

### **FUNCTION:impb?**

Description: Query the secondary parameter  
(only effective in L,C,R,Z)

Return: <D, Q, THETA, ESR, NULL>

### **FUNCTION:EQUIvalent < SERIES | parallel | PAL >**

Description: Set the equivalent mode  
(only effective in L,C,R,Z)

Parameters: SERIES — series mode

Parallel — parallel mode

Pal — parallel mode

Example: FUNCTION:EQUIvalent SERIES

Set the equivalent mode to series mode

### **FUNCTION:EQUIvalent?**

Description: Query the equivalent mode

Return: <SER, PAL>

---

## CALCulate subsystem

### **CALCulate:TOLerance:STATe < ON | OFF >**

Description: Enable or disable tolerance mode

Example: CALCulate: TOLerance:STATe ON

### **CALCulate:TOLerance:STATe?**

Description: Query the tolerance mode

Return: <ON, OFF >

### **CALCulate:TOLerance:NOMinal?**

Description: Query the nominal value

Return: NR3 or -----(exceeding data range)

### **CALCulate:TOLerance:VALUe?**

Description: Query the percentage value of tolerance

Return: NR3 or ----- (exceeding data range)

### **CALCulate:TOLerance:RANGe < 1 | 5 | 10 | 20 >**

Description: Set tolerance range as 1%,5%,10% or 20% (20% not available for some models )

Example: CALCulate:TOLerance:RANGe 1

Set the tolerance range to 1%

### **CALCulate:TOLerance:RANGe?**

Description: Query the tolerance range

Return: <BIN1, BIN2, BIN3, BIN4 or ---- >

“----” means unset bin

---

### **CALCulate:RECOrding:STATe < ON | OFF >**

Description: Enable or disable recording function

Example: CALCulate:RECOrding:STATe ON

### **CALCulate:RECOrding:STATe?**

Description: Query the recording state

Return: <ON or OFF>

### **CALCulate:RECOrding:MAXimum?**

Description: Query the maximum value of recording function

Return: <NR3, NR3> ( primary and secondary parameters, when data exceeds limits or there is no data, what returns is “----” .)

### **CALCulate:RECOrding:MINimum?**

Description: Query the minimum value of recording function

Return: <NR3, NR3> ( primary and secondary parameters, when data exceeds limits or there is no data, what returns is “----” .)

### **CALCulate:RECOrding:AVERage?**

Description: Query the average value of recording function

Return: <NR3, NR3> ( primary and secondary parameters, when data exceeds limits or there is no data, what returns is “----” .)

### **CALCulate:RECOrding:PRESent?**

Description: Query the present value of



---

recording function  
Return: <NR3, NR3> ( primary and secondary parameters, when data exceeds limits or there is no data, what returns is “----” .)

## **FETCh Subsystem**

### **FETCh?**

Description: Returns the primary, secondary display value and tolerance compared result (BIN no.).

Return: <NR3, NR3, NR1> when the primary parameter is LCR,  
Primary parameter, secondary parameter and BIN no.

<NR3, NR1> when the primary parameter is DCR,  
Primary parameter and BIN no.

Example: FETCh?

---

## Summary of Supported SCPI Commands

**Table 7 - Summary of SCPI Commands**

Command	Parameter	Explanation
FREQuency	<Value>	Set the Test Frequency
FREQuency?		Query the Test Frequency
VOLTage	<Value>	Set the Test level
VOLTage?		Query the Test level
FUNction		
:impa	<Literal>	Select the primary display parameter
:impa?		Query the primary display parameter
:impb	<Literal>	Select the secondary display parameter
:impb?		Query the secondary display parameter
:EQUivalent	<Literal>	Set the equivalent mode
:EQUivalent?		Query the equivalent mode
CALCulate		
:TOLerance		
:STATe	<Boolean>	Enable/disable the tolerance mode
:STATe?		Query the tolerance mode
:NOMinal?		Query the nominal value
:VALUe?		Query the percent of

		tolerance
:RANG	<Value>	Set the limit bin
:RANGe?		Query the limit bin
:RECORDing		
:STATe	<Boolean>	Enable/disable the recording function
:STATe?		Query the recording state
:MAXimum?		Query the max. value of recording
:MINimum?		Query the min. value of recording
:AVERage?		Query the average value of recording
:PRESent?		Query the test value of recording
FETCH?		Query the measurement result

## ***Error Codes***

If codes or parameters, originated from bus and transmitted to the meter, are fault, the meter will terminate the analysis and execution codes. At the same time, error code will be displayed on LCD and beep will be sound.

Below defines the error description based on the error code.

---

E10: Unknown command

E11: Parameter Error

E12: Syntax Error

## Specifications

Below are the general specification and the accuracy specification of ST2822D and ST2822E.

**Declaration:** The specifications are subject to change without notice.

\*NOTE: 120Hz is the listed frequency. The actual frequency is 120.048Hz.

## General Specifications

Function		
Measurement Parameters		Primary: L/C/R/Z/DCR Secondary: D/Q/θ/ESR
Equivalent Mode		Series, Parallel
Auto LCR Function		Manual, Auto
Ranging Mode		Auto
Test Terminals		3-terminal, 5-terminal
Measurement Speed	LCRZ	4 meas/sec, 1.5meas/sec
	DCR	3 meas/sec, 2.5meas/sec
Correction		Short, open
Tolerance Mode		1%, 5%, 10%, 20%
Input Protection Fuse		0.1A / 63V
Interface		Mini-USB (virtual serial port)
Test Signal		
Signal Frequency (0.02% accuracy)	ST2822 D	100Hz, 120Hz*, 1kHz, 10kHz
	ST2822E	100Hz, 120Hz*, 1kHz, 10kHz, 100kHz

Test Signal Level(10% accuracy)		0.3 Vrms, 0.6 Vrms, 1 Vrms DCR signal: 1Vdc	
Output Impedance		100Ω	
<b>Display</b>			
Display		LCD primary-secondary dual display	
Backlight		Battery supply: when backlight is on, luminance is reduced by half 15s later and automatically turned off 30s later. Powered by adapter: backlight off until manually turned off	
Count		Max. Counts of Primary Parameter: 40,000; D / Q / θ Min. resolution of secondary parameter: 0.0001.	
Basic Accuracy		0.1% (see accuracy specifications for details)	
Primary Range and Resolution		See Accuracy Specifications	
Secondary Parameter		Range for Display	Resolution
	ESR	0.0000W -- 999.9Ω	0.0001Ω
	D	0.0000 -- 9.999	0.0001
	Q	0.0000 -- 9999	0.0001
	θ	-179.9° -- 179.9°	0.01°

<b>Power Supply</b>	
Battery Model	LH-200H7C,8.4V Ni-MH 200mAH rechargeable battery
AC Adapter	Input: 220V ( $\pm 10\%$ ), 50Hz ( $\pm 5\%$ ) Output: 12V-15V DC
Operating Current (with backlight off)	Max.:35mA Typical:25mA (@1kHz, 0.6 Vrms,100 $\Omega$ load)
Standby(Power Off)Current	Max. :11 $\mu$ A
Battery Life	16 Hours (typical) based on backlight off and new alkaline
	6 Hours (typical) based on backlight off and new fully charged Ni-MH battery
Charge Time and Current	Max.: 160min Max. Current: 100mA
Auto Power Off(valid for battery powered)	5min/15min/30min/60min/OFF available ; factory default :5min
Low Voltage Indicator	When battery voltage drops below 6.8V, Low Voltage Indicator turns on

<b>General</b>		
Operation Condition	Temperature	0°C -- 40°C
	Relative Humidity	≤90% R.H.
Weight		350g
Dimensions (H ´ W ´ D)		190mm * 90mm * 41mm
Safety and EMC compliance		IEC 61010-1:2001 IEC 61326-2-1:2005



---

## Accuracy Specifications

### Notices

1. Environment temperature:  $23^{\circ}\text{C}\pm 5^{\circ}\text{C}$ ;  
Humidity:  $\leq 75\%$  R.H.
2. Valid after 10 minutes of warm up time.
3. Test in measuring slots on front panel.
4. Measurements performed after correct open and short correction.
5. Test in the recommended equivalent mode.
6. Percentage discrepancy Indication:  
 $\pm(\% \text{reading} + \text{number of least significant digits})$
7. Actual measurement and display range exceed the ranges specified in table, but we do not assign accuracy for measurement values exceeding these ranges.
8. When the test level is 0.3V: accuracy\*2
9. Subscript Explanation:  
S—series equivalent; p—parallel equivalent;  
e: accuracy

10. Some parameters cannot be expressed as the way of data sheet; therefore they can just be converted by formulas according to corresponding results.

### Inductance (L) and Quality Factor (Q)

Range		Display Range	Accuracy Le	Accuracy De *	Recommended Equivalent Mode
<b>100Hz/120Hz</b>	1000H	400.0H~1000.0H	1.00%+ 3 digits	0.0100	Parallel
	400H	40.00H~399.99H	0.35%+ 2 digits	0.0035	Parallel
	40H	4.000H~39.999H	0.10%+ 2 digits	0.0010	Parallel
	4H	400.0mH~3.9999H	0.10%+ 2 digits	0.0010	----
	400mH	40.00mH~399.99mH	0.10%+ 2 digits	0.0010	Series
	40mH	4.000mH~39.999mH	0.45%+ 2 digits	0.0045	Series
	4mH	0 $\mu$ H~3.999mH	1.40%+ 5 digits	-----	Series
<b>1kHz</b>	100H	40.00H~100.00H	1.00%+ 3 digits	0.0100	Parallel
	40H	4.000H~39.999H	0.35%+ 2 digits	0.0035	Parallel
	4H	400.0mH~3.9999H	0.10%+ 2 digits	0.0010	Parallel

	400mH	40.00mH~399.99mH	0.10%+ 2 digits	0.0010	----
	40mH	4.000mH~39.999mH	0.10%+ 2 digits	0.0010	Series
	4mH	400.0μH~3.9999mH	0.45%+ 2 digits	0.0045	Series
	400μH	0.0μH~399.9μH	1.40%+ 5 digits	-----	Series
<b>10kHz</b>	1000mH	400.0mH~999.99mH	0.80%+ 3 digits	0.0080	Parallel
	400mH	40.00mH~399.99mH	0.35%+ 2 digits	0.0035	Parallel
	40mH	4.000mH~39.999mH	0.10%+ 2 digits	0.0010	----
	4mH	400.0μH~3.9999mH	0.30%+ 2 digits	0.0030	Series
	400μH	40.00μH~399.99μH	0.45%+ 2 digits	0.0045	Series
	40μH	0.00μH~39.99μH	1.40%+ 5 digits	-----	Series
<b>100kHz</b>	100mH	40.00mH~399.99mH	1.20%+ 5 digits	0.0120	Parallel
	40mH	4.000mH~39.999mH	0.80%+ 2 digits	0.0080	Parallel
	4mH	400.0μH~3.9999mH	0.50%+ 2 digits	0.0050	----
	400μH	40.00μH~399.99μH	0.50%+ 2 digits	0.0050	Series
	40μH	4.000μH~39.999μH	0.80%+ 5 digits	0.0080	Series
	4μH	0.000μH~3.999μH	2.50%+ 10 digits	-----	Series

\*Note: Accuracy of De is assessed when De <0.5

Quality factor Q and Accuracy Qe is calculated by the following formula:

For  $Q_x \times D_e \leq 1$ ,

$$Q_e = \pm \frac{Q_x^2 \times D_e}{1 \mp Q_x \times D_e}$$

$Q_x$  is the measurement value.

### Capacitance(c) and Dissipation (D)

Range	Display Range	Accuracy Ce	Accuracy De*	Recommended Equivalent Mode	
<b>100Hz/120Hz</b>	20mF	4.000mF~20.000mF	5.00%+5 digits	±0.0500	Series
	4mF	400.0μF~3.9999mF	1.00%+3 digits	±0.0100	Series
	400μF	40.00μF~399.99μF	0.35%+2 digits	±0.0035	Series
	40μF	4.000μF~39.999μF	0.10%+2 digits	±0.0010	Series
	4μF	400.0nF~3.9999μF	0.10%+2 digits	±0.0010	---
	400nF	40.00nF~399.99nF	0.10%+2 digits	±0.0010	Parallel
	40nF	4.000nF~39.999nF	0.35%+3 digits	±0.0035	Parallel

	4nF	0pF~3.999nF	1.25%+5 digits	-----	Parallel
<b>1kHz</b>	1000μF	400.0μF~999.99μF	2.00%+5 digits	±0.0200	Series
	400μF	40.00μF~399.99μF	1.00%+3 digits	±0.0100	Series
	40μF	4.000μF~39.999μF	0.35%+2 digits	±0.0035	Series
	4μF	400.0nF~3.9999μF	0.10%+2 digits	±0.0010	Series
	400nF	40.00nF~399.99nF	0.10%+2 digits	±0.0010	----
	40nF	4.000nF~39.999nF	0.10%+2 digits	±0.0010	Parallel
	4nF	400.0pF~3.9999nF	0.35%+3 digits	±0.0035	Parallel
	400pF	0.0pF~39.99nF	1.25%+5 digits	-----	Parallel
<b>10kHz</b>	100μF	40.00μF~100.00μF	3.00%+5 digits	±0.0300	Series
	40μF	4.000μF~39.999μF	1.50%+3 digits	±0.0150	Series
	4μF	400.0nF~3.9999μF	0.35%+2 digits	±0.0035	Series
	400nF	40.00nF~399.99nF	0.10%+2	±0.0010	Series

			digits		
	40nF	4.000nF~39.999nF	0.10%+2 digits	±0.0010	----
	4nF	400.0pF~3.9999nF	0.10%+2 digits	±0.0010	Parallel
	400pF	40.00pF~399.99pF	0.35%+3 digits	±0.0035	Parallel
	40pF	0.00pF~39.99pF	1.25%+5 digits	-----	Parallel
<b>100kHz</b>	10μF	4.000μF~10.000μF	6.00%+20 digits	±0.0600	Series
	4μF	400.0nF~3.9999μF	2.50%+10 digits	±0.0250	Series
	400nF	40.00nF~399.99nF	0.80%+5 digits	±0.0080	Series
	40nF	4.000nF~39.999nF	0.50%+2 digits	±0.0050	Series
	4nF	400.0pF~3.9999nF	0.50%+2 digits	±0.0050	----
	400pF	40.00pF~399.99pF	0.80%+2 digits	±0.0080	Parallel
	40pF	4.000pF~39.999pF	1.20%+5 digits	±0.0120	Parallel
	4pF	0.000pF~4.999pF	3.00%+10 digits	-----	Parallel

Impedance (Z), Phase Angle ( $\theta$ ) and DCR

Range	Display Range	Accuracy $Z_e$	Accuracy $\theta_e$	Recommended Equivalent Mode	
<b>100Hz -- 10kHz</b>	10M $\Omega$	4.000M $\Omega$ ~10.000M $\Omega$	3.00%+5 digits	$\pm 1.75^\circ$	Parallel
	4M $\Omega$	400.0k $\Omega$ ~3.9999M $\Omega$	1.25%+3 digits	$\pm 0.75^\circ$	Parallel
	400k $\Omega$	40.00k $\Omega$ ~399.99k $\Omega$	0.35%+2 digits	$\pm 0.25^\circ$	Parallel
	40k $\Omega$	4.000k $\Omega$ ~39.999k $\Omega$	0.10%+2 digits	$\pm 0.10^\circ$	Parallel
	4k $\Omega$	400.0 $\Omega$ ~3.9999k $\Omega$	0.10%+2 digits	$\pm 0.10^\circ$	----
	400 $\Omega$	40.00 $\Omega$ ~399.99 $\Omega$	0.10%+2 digits	$\pm 0.10^\circ$	Series
	40 $\Omega$	4.000 $\Omega$ ~39.999 $\Omega$	0.35%+2 digits	$\pm 0.25^\circ$	Series
	4 $\Omega$	0.4000 $\Omega$ ~3.9999 $\Omega$	1.00%+3 digits	$\pm 0.60^\circ$	Series
	0.4 $\Omega$	0.0000 $\Omega$ ~0.3999 $\Omega$	3.00%+5 digits	-----	Series

100kHz	10M $\Omega$	4.000M $\Omega$ ~10.000M $\Omega$	8.00%+20 digits	$\pm 4.60^\circ$	Parallel
	4M $\Omega$	400.0k $\Omega$ ~3.9999M $\Omega$	3.00%+10 digits	$\pm 1.75^\circ$	Parallel
	400k $\Omega$	40.00k $\Omega$ ~399.99k $\Omega$	1.20%+5 digits	$\pm 0.69^\circ$	Parallel
	40k $\Omega$	4.000k $\Omega$ ~39.999k $\Omega$	0.80%+2 digits	$\pm 0.46^\circ$	Parallel
	4k $\Omega$	400.0 $\Omega$ ~3.9999k $\Omega$	0.50%+2 digits	$\pm 0.30^\circ$	----
	400 $\Omega$	40.00 $\Omega$ ~399.99 $\Omega$	0.50%+2 digits	$\pm 0.30^\circ$	Series
	40 $\Omega$	4.000 $\Omega$ ~39.999 $\Omega$	0.80%+5 digits	$\pm 0.46^\circ$	Series
	4 $\Omega$	0.4000 $\Omega$ ~3.9999 $\Omega$	2.50%+10 digits	$\pm 1.43^\circ$	Series
	0.4 $\Omega$	0.0000 $\Omega$ ~0.3999 $\Omega$	6.00%+20 digits	-----	Series



<b>DCR</b>	20MΩ	4.000MΩ~20.000MΩ	2.00%+20 digits	-----	-----
	4MΩ	400.0kΩ~3.9999MΩ	1.00%+10 digits	-----	-----
	400kΩ	40.00kΩ~399.99kΩ	0.50%+5 digits	-----	-----
	40kΩ	4.000kΩ~39.999kΩ	0.10%+2 digits	-----	-----
	4kΩ	400.0Ω~3.9999kΩ	0.10%+2 digits	-----	-----
	400Ω	40.00Ω~399.99Ω	0.10%+2 digits	-----	-----
	40Ω	4.000Ω~39.999Ω	0.10%+2 digits	-----	-----
	4Ω	0.4000Ω~3.9999Ω	0.50%+10 digits	-----	-----
0.4Ω	0.0000Ω~0.3999Ω	2.00%+20 digits	-----	-----	

### Equivalent Series Resistance

Accuracy of equivalent series resistance is calculated according to the below formula:

$$R_{se} = \pm X_x \times \phi_e$$

---

$X_x$  : actual impedance,

$$X_x = 2\pi f L_x$$

Or

$$X_x = \frac{1}{2\pi f C_x}$$

$\phi_e$  is the phase angle accuracy,  $\phi_e = \theta_e \times \frac{\pi}{180}$

**Notice:** The accuracies of ESR and Rs are same.

### Equivalent Parallel Resistance

Accuracy of equivalent series resistance is calculated according to the below formula:

$$R_{pe} = \pm \frac{R_{px} \times \phi_e}{D_x \mp \phi_e}$$

Rpx is the measurement value of Rp, Dx is the dissipation value.

---

# Maintenance

**WARNING: Do not perform any service by yourself. Service should only be done by qualified personnel and trained technicians.**

**WARNING: Beware of liquid and residues, especially conductive matter.**

## Service

If the instrument fails to power on, first check battery, external source and power sockets and the validity of buttons.

If the measurement result is abnormal, first inspect the condition of test accessories and damage of reed in test slots. See operation manual for conformation of correct operation.

Do not replace components. Contact the after-sale department of our company or relevant distributors for uncertain maintenance.

---

The meter must be turned off or removed from external power before replacing battery. See Installing Battery section for details.

## **Cleaning**

Before cleaning this meter, make sure the power is OFF and remove external AC adapter if one is used.

To avoid electrical shock or damaging the meter, prevent water from getting inside the case. In the case that water gets inside, remove the battery immediately and do not operate the instrument immediately.

To clean the meter, wipe the dirty parts with a soft cloth soaked with diluted neutral detergent. Avoid having the instrument too wet to prevent the detergent from penetrating into the inside components of the meter, causing damages.

After cleaning, make sure the instrument is completely dried before operating it again.

---

## Limited Warranty

The instrument, component parts and accessories will be free from defects in workmanship and materials for a period of two years from date of purchase.

Sourcetric will, without charge, repair or replace, at its option, defective product or component parts. Returned product must be accompanied by proof of the purchase date in the form of a sales receipt and the included accessories.

This warranty does not apply in the event of misuse or abuse of the product or as a result of unauthorized alterations or repairs.

The warranty is void if the serial number is altered, defaced or removed.

SOURCETRONIC GMBH  
Fahrenheitstrasse 1  
28359 Bremen  
Germany

T +49 421 2 77 99 99  
F +49 421 2 77 99 98  
info@sourcetric.com  
www.sourcetric.com  
skype: sourcetric

